

Kongsberg K-Sync Synchronizing Unit

Product description

Kongsberg Maritime

Document history

Document number: 342385		
Rev. A	December 2009	First version.
Rev. B	March 2010	Minor changes – new picture

Note

The information contained in this document remains the sole property of Kongsberg Maritime AS. No part of this document may be copied or reproduced in any form or by any means, and the information contained within it is not to be communicated to a third party, without the prior written consent of Kongsberg Maritime AS.

Kongsberg Maritime AS endeavours to ensure that all information in this document is correct and fairly stated, but does not accept liability for any errors or omissions.

Warning

The equipment to which this manual applies must only be used for the purpose for which it was designed. Improper use or maintenance may cause damage to the equipment and/or injury to personnel. The user must be familiar with the contents of the appropriate manuals before attempting to operate or work on the equipment.

Kongsberg Maritime disclaims any responsibility for damage or injury caused by improper installation, use or maintenance of the equipment.

Comments

To assist us in making improvements to the product and to this manual, we welcome comments and constructive criticism.

e-mail: km.documentation@kongsberg.com

Kongsberg Maritime AS

Strandpromenaden 50
P.O.Box 111
N-3191 Horten,
Norway

Telephone: +47 33 02 38 00
Telefax: +47 33 04 47 53
www.kongsberg.com
subsea@kongsberg.com



KONGSBERG

Table of contents

1	SYSTEM OVERVIEW	5
2	TRIGGER GROUPS	7
2.1	Trigger display.....	8
3	ECHO SOUNDER STATUS	10
3.1	Enable/disable echo sounder	10
4	DIAGNOSTIC TOOL	11
5	TECHNICAL SPECIFICATIONS	12
6	DRAWINGS	13

1 SYSTEM OVERVIEW

The Synchronizing Unit schedules the echo sounders to transmit according to trigger groups. There are a total of 16 trigger groups and any number of echo sounders can be assigned to a group (zero or more). Each group is triggered consecutively, while the echo sounders assigned to a group are triggered at the same time. Once it is determined (by reading feedback signals) or estimated (based on user settings) that all echo sounders in the current group have completed their ping cycle, then the next group is triggered. All groups are triggered in round-robin fashion. The duration of each group is not fixed and depends upon what the maximum *active period* is for the echo sounders in that group.

Echo sounders can be taken out of the schedule without changing the group schedule, by simply disabling it. If a group does not contain any available echo sounders, then that group is skipped.

The Synchronizing Unit system consists of two main components:

- A Workstation PC running the Synchronizing Unit (SU) application.
- A Synchronizing Unit that interfaces with the echo sounders.

Figure 1 System Overview

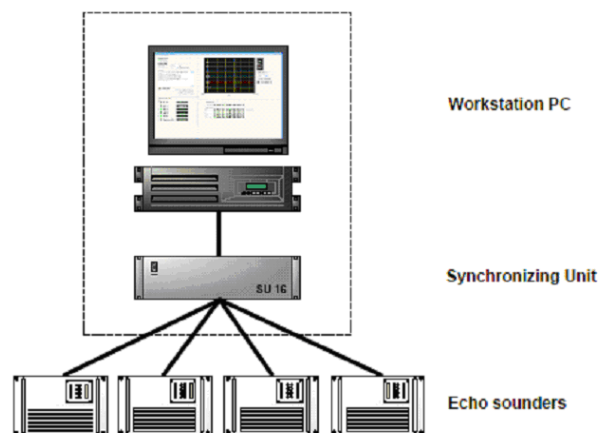

The Synchronizing Unit application provides the user interface, which allows monitoring of status, modifying settings, trigger schedule as well as performing diagnostics. The application needs to run and be connected to the Synchronizing Unit in order for the system to initialize and be operational. However, once the system is running, the application can be shut down and disconnected completely while the Synchronizing Unit continues to control the triggering of echo sounders.

The Synchronizing Unit controls pinging and receives status from the echo sounders via the signal interface. A trigger output is provided for each echo sounder as well as inputs for receiving feedback signals from echo sounders. Feedback signals are not required, but will be used when available. If feedback signals are not available, the Synchronizing Unit can estimate the period required for the echo sounder to become ready.

2 TRIGGER GROUPS

The trigger groups are the basis for the scheduling of the echo sounders. The Synchronizing Unit uses the runtime parameters to determine the individual timing of the echo sounders, while the trigger groups specify in what order and which echo sounders will transmit together.

The display consists of two parts:

- 1 Active group indicator (see Fig. *Trigger status* on page 7).
- 2 Trigger schedule.

The active group indicator shows which group is currently active. Groups that do not have any echo sounders assigned to them are skipped. A maximum of 16 groups can be scheduled. Since each echo sounder has different timing requirements, the duration of each group will depend upon which echo sounders are assigned to the group (i.e. longest active period of the echo sounders).

Figure 2 Trigger status

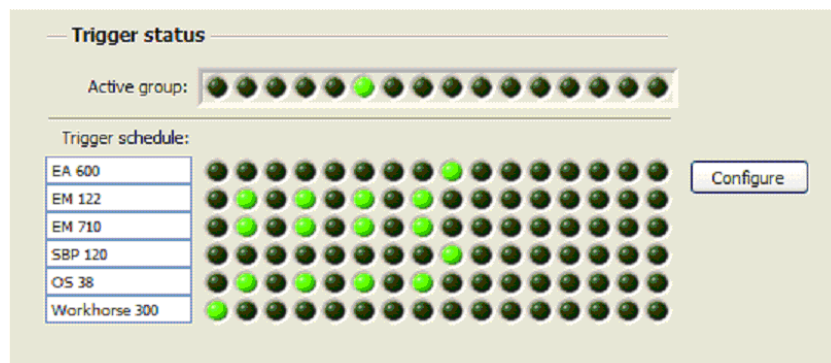

Trigger status shows which is the current group and which group each echo sounder is assigned to

The trigger schedule shows one system per row, and the trigger groups are shown across. A green LED designates that the echo sounder has been assigned to that group. To modify the schedule, click configure. And check the groups that an echo sounder should be assigned to (see Fig. *Trigger groups* on page 8).

Figure 3 Trigger groups

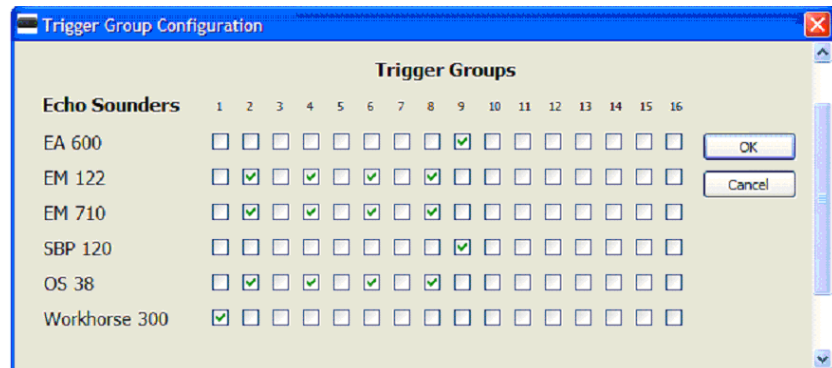

Trigger group configuration dialogue allows user to assign echo sounders to trigger groups

2.1 Trigger display

The trigger display is a real-time display that shows the current state of each echo sounder plotted across time. There are two plots for each echo sounder:

- 1 Trigger plot
- 2 State plot

The trigger plot shows a pulse whenever the Synchronizing Unit is triggering the echo sounder. This line is blue.

The state plot shows the current state based on scheduling and feedback signals and is conveyed by its colour.

Table 1 Interpretation of trigger display plots

	State plot	Gray line	Echo sounder has been disabled by operator or the echo sounder is in Standby state (i.e. timed out/not ready)
		Green line	Echo sounder is ready to be triggered
		Red line	Echo sounder is currently transmitting, receiving and/or processing samples (i.e. not ready)
		Red pulse	Echo sounder acknowledged that a transmit occurred (width of pulse is always constant)
	Trigger plot	Blue pulse	Trigger pulse

Each trigger group is visually separated by the vertical group line in yellow.

By inspecting the trigger chart for a particular group it is possible to see which echo sounder is taking the longest to complete the ping cycle. This echo sounder will have a red line that starts at the beginning and extends all the way to the end of the group.

Figure 4 OS 38 – Echo sounder

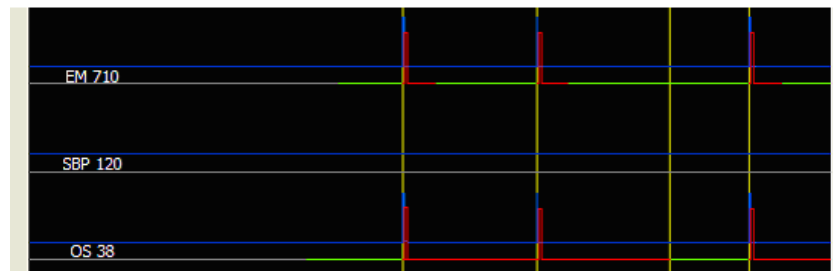

This plot shows an echo sounder, OS 38, which has the longest period in the group and consequently determines the overall ping rate for the groups it is assigned to.

3 ECHO SOUNDER STATUS

The individual states of the echo sounders are shown in the Echo sounder status display. For each echo sounder there is also a check box for enabling and disabling the system.

Figure 5 Echo Sounder Status

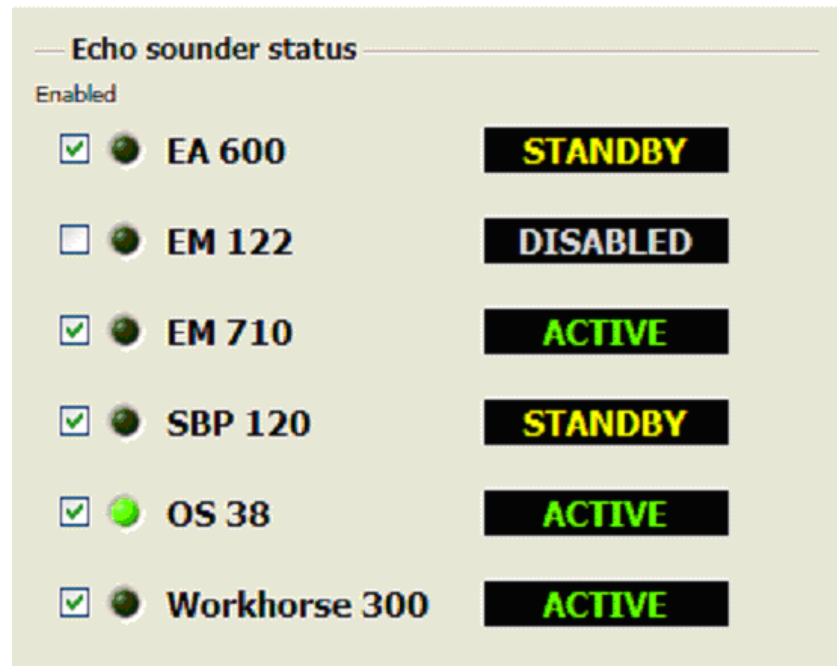

The Echo sounder status provides synchronizing status for each of the installed echo sounders

3.1 Enable/disable echo sounder

Even if an echo sounder is scheduled, it can be overridden by enable/disable setting. If enabled (checked) it will be triggered according to the schedule, if disabled (unchecked) it will not be triggered even if scheduled. This setting is seen in the check box on the left hand side of the Echo sounder status area of the user interface.

4 DIAGNOSTIC TOOL

The diagnostic display shows the signal level on each input and output of the Synchronizing Unit. There are 48 inputs (feedback signals) and 16 outputs (trigger signals).

In Fig. *Diagnostic Display* on page 11, the dialogue for the diagnostic display is shown. The label next to each LED describes which module and pin number as well as terminal ID the state is associated with. The module and pin number refer to the physical connections inside the Synchronizing Unit, while the terminal ID refer to the selections in the installation settings.

Note

The LEDs refer to the actual voltage level on the input (referred to as 5 V). If signal conditioning has been applied, the states may become inverted.

Figure 6 *Diagnostic Display*

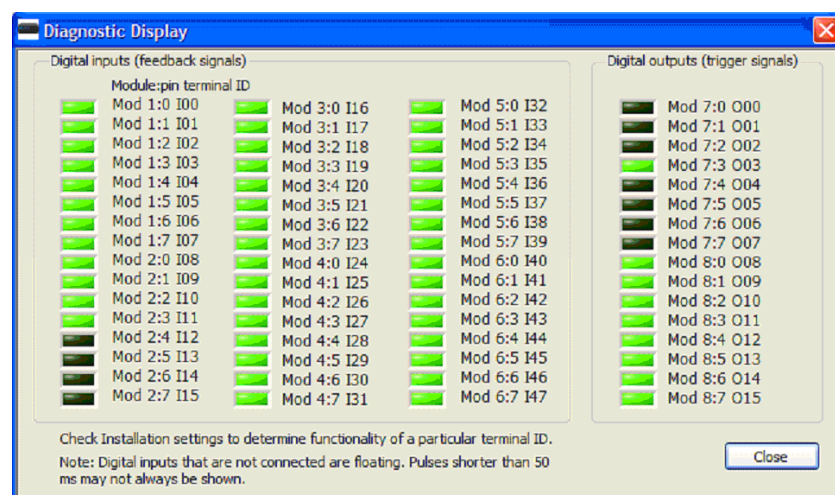

The Diagnostic Display dialogue shows the signal level of each digital input and output.

5 TECHNICAL SPECIFICATIONS

Some of the timing and signal specifications with respect to the K-Sync are listed in the table below.

Display resolution (horizontal):	50 ms
Display width:	10, 30 or 60 seconds
Max. trigger groups:	16
Timing resolution of synchronization:	1 ms
Available signal inputs:	48
Max systems/trigger outputs:	16
Supported signal levels (inputs and outputs):	TTL and RS-232
Signal latency (feedback signal to trigger output):	40 μ s
Supported depth datagram input:	<ul style="list-style-type: none">• EMx: D, X, and E• EA 500• NMEA: DPT and DBS

6 DRAWINGS

- SSU Rack Unit
- Outline Dimensions Cabinet

The copyright of this drawing and of all annexes which are entrusted to a person's care always remain the property of Kongsberg Maritime AS. They must not be copied or duplicated nor shown to or placed at the disposal of third persons without our written consent.

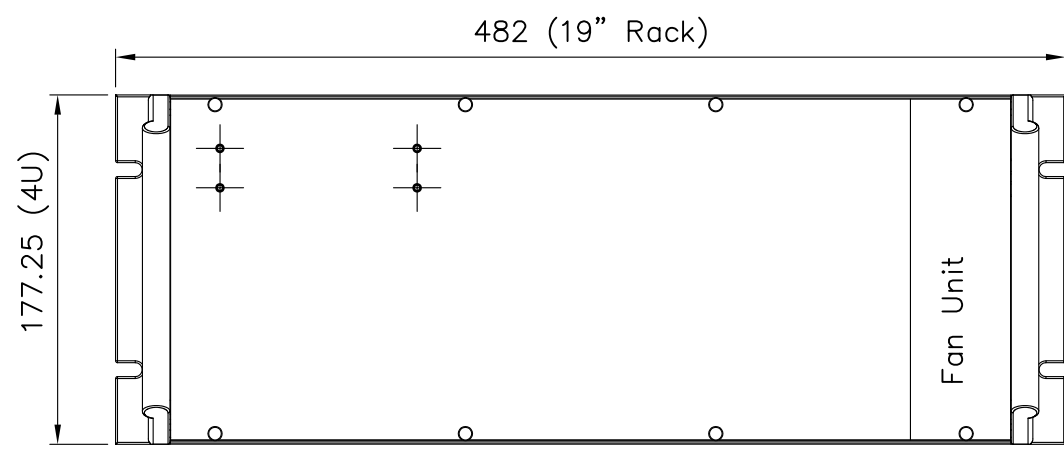

Front View

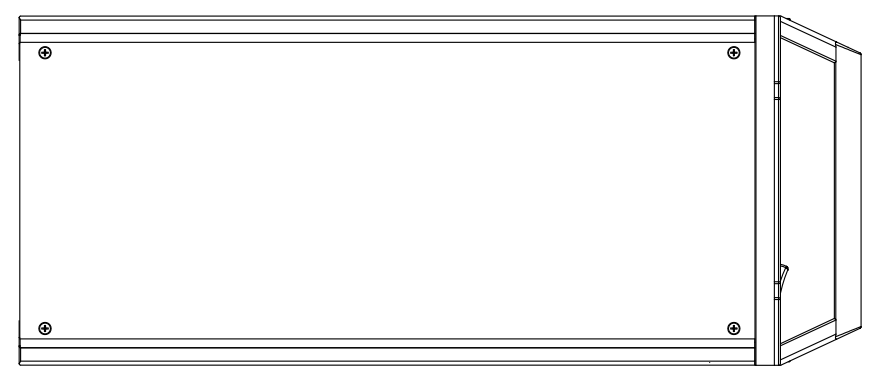

Side View

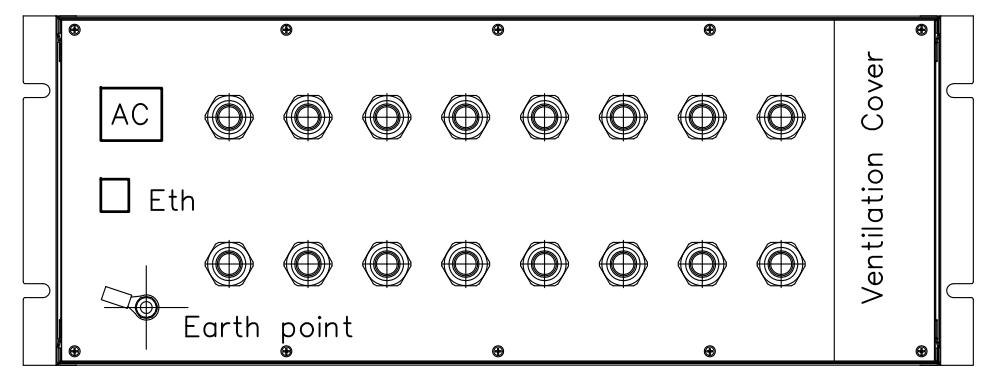

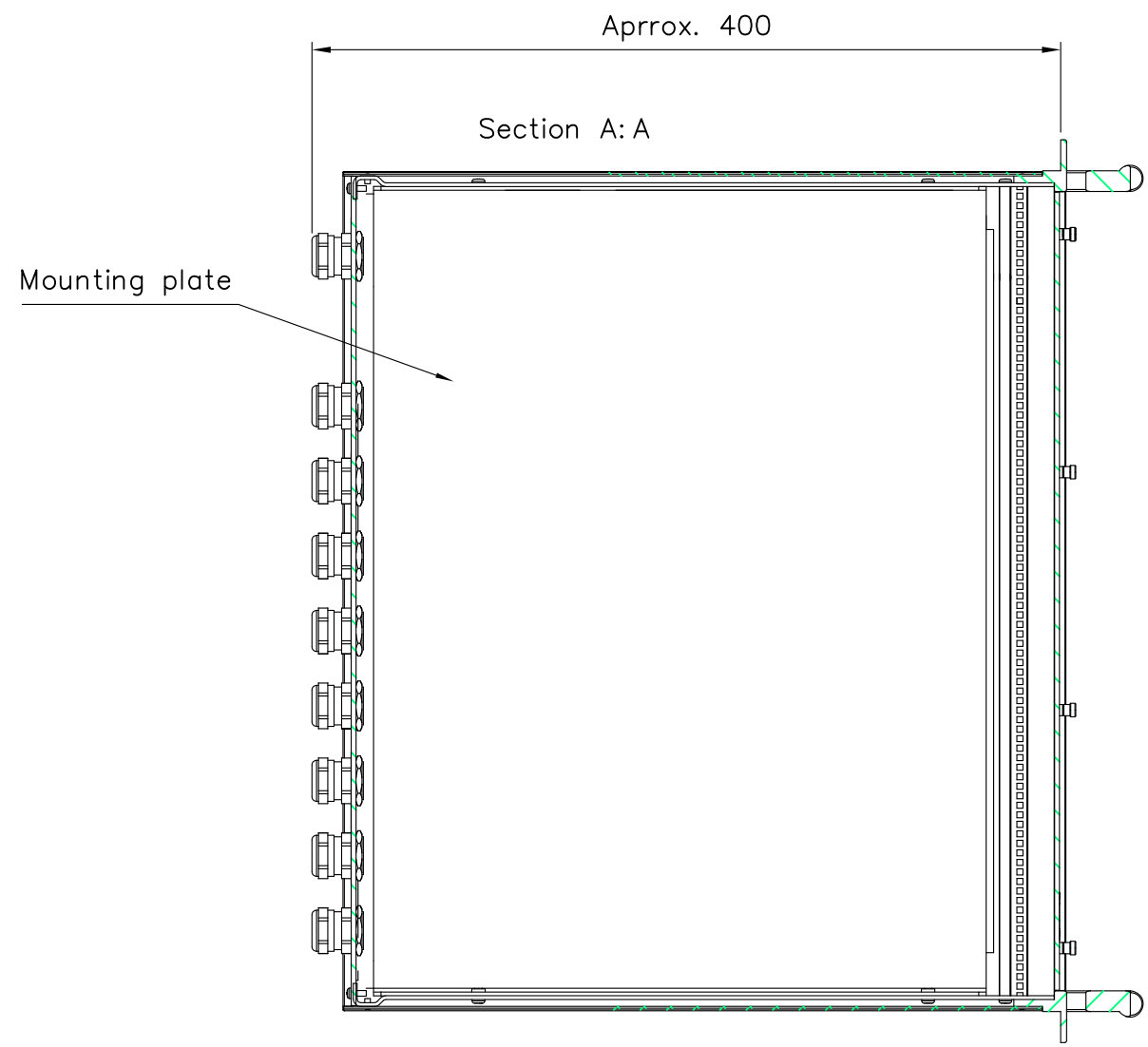

Rear View



PRELIMINARY

ELMA Parts: 15A03444-30 (1x Box) 15A109-01 (1x Mount. Plate)
 21C484(x1)/563-098871(18)/560-096468(x8)/560-098813 (10) (Front)
 21A484 (x1 Rear panel)

-	-	-
ISSUE	DATE	SIGN

SSU Rack Unit			SCALE 1:4	 Kongsberg Maritime AS Hydroacoustics Division - Horten		
EMx				KONGSBERG		
DATE 2008.02.14	DESIGNED HF	CHECKED	APPROVED	PROJ. METHODE 	DWG.NO. Sketch	REV. P1
UNLESS OTHERWISE STATED, TOLERANCES: DIM.: ISO 2768-mK THREADS: 6g/6H SURFACE: Ra6.3				SIZE A3	SHEET 1 OF 1	FILE NO: CAD03

The copyright of this drawing and of all annexes which are entrusted to a person's care always remain the property of Kongsberg Maritime AS. They must not be copied or duplicated nor shown to or placed at the disposal of third persons without our written consent.

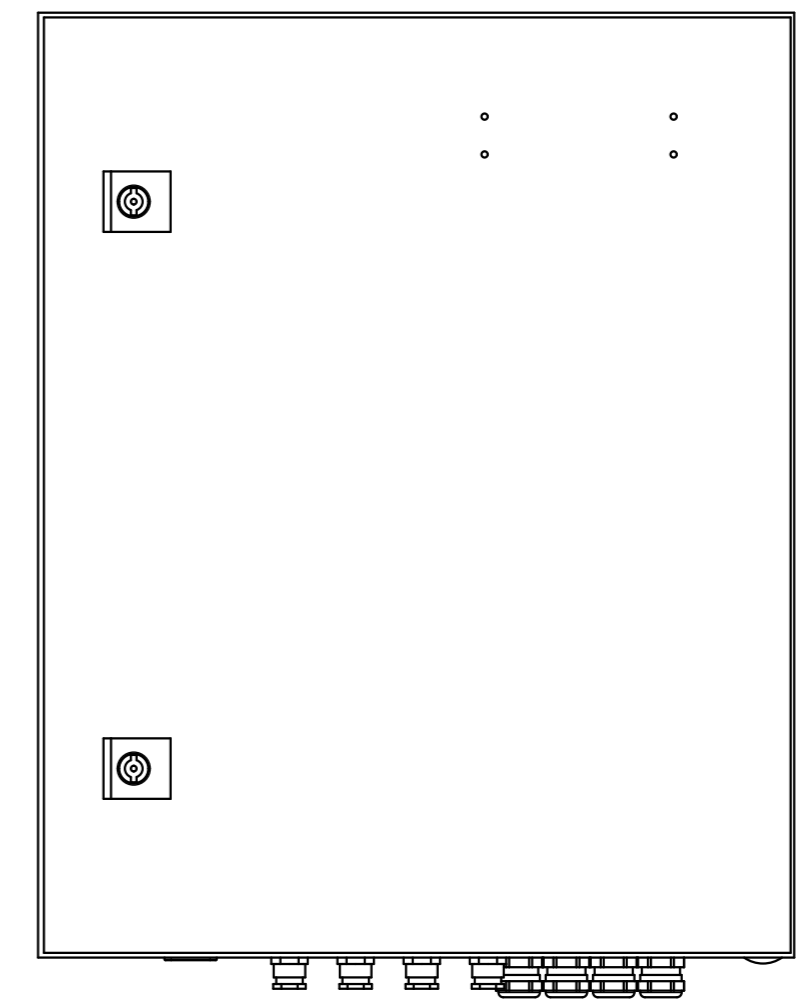
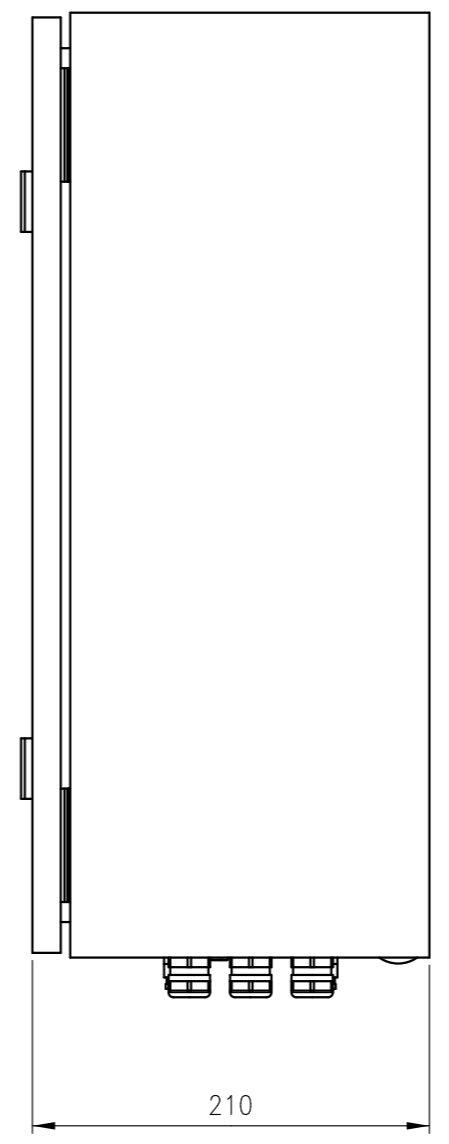
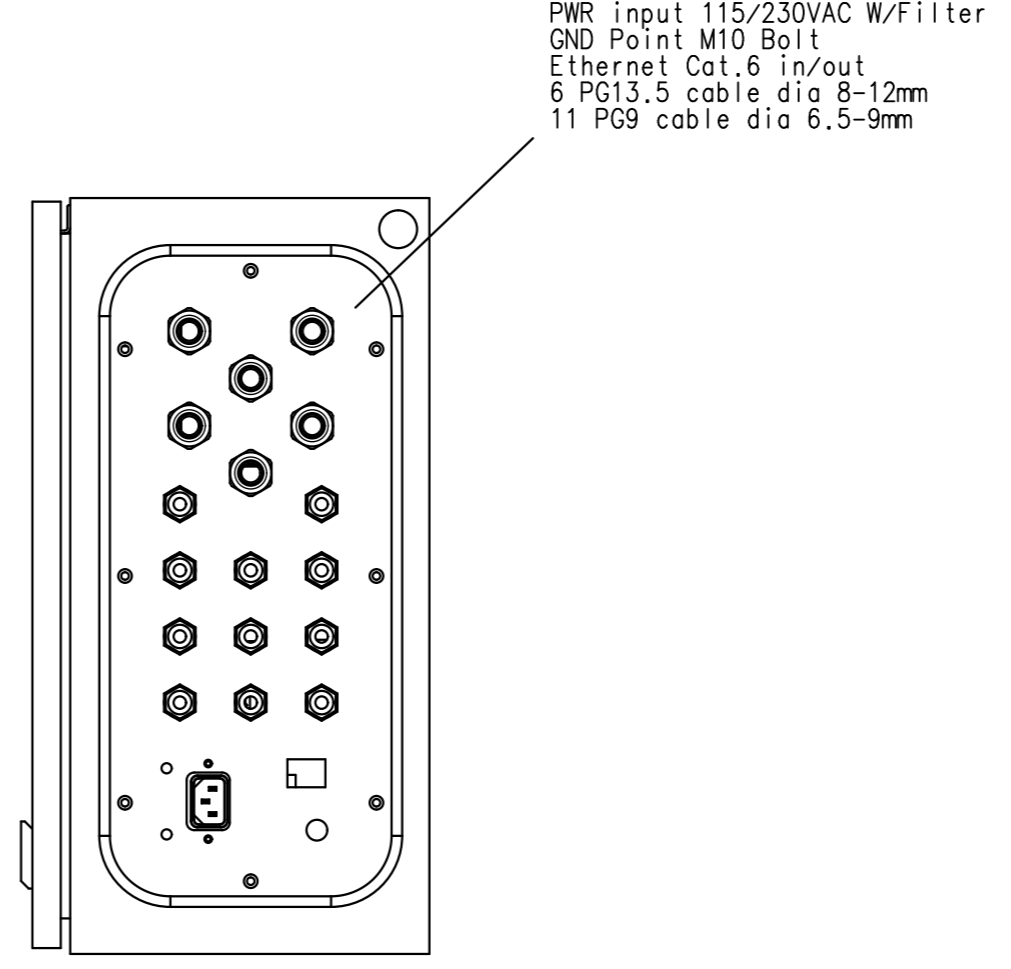
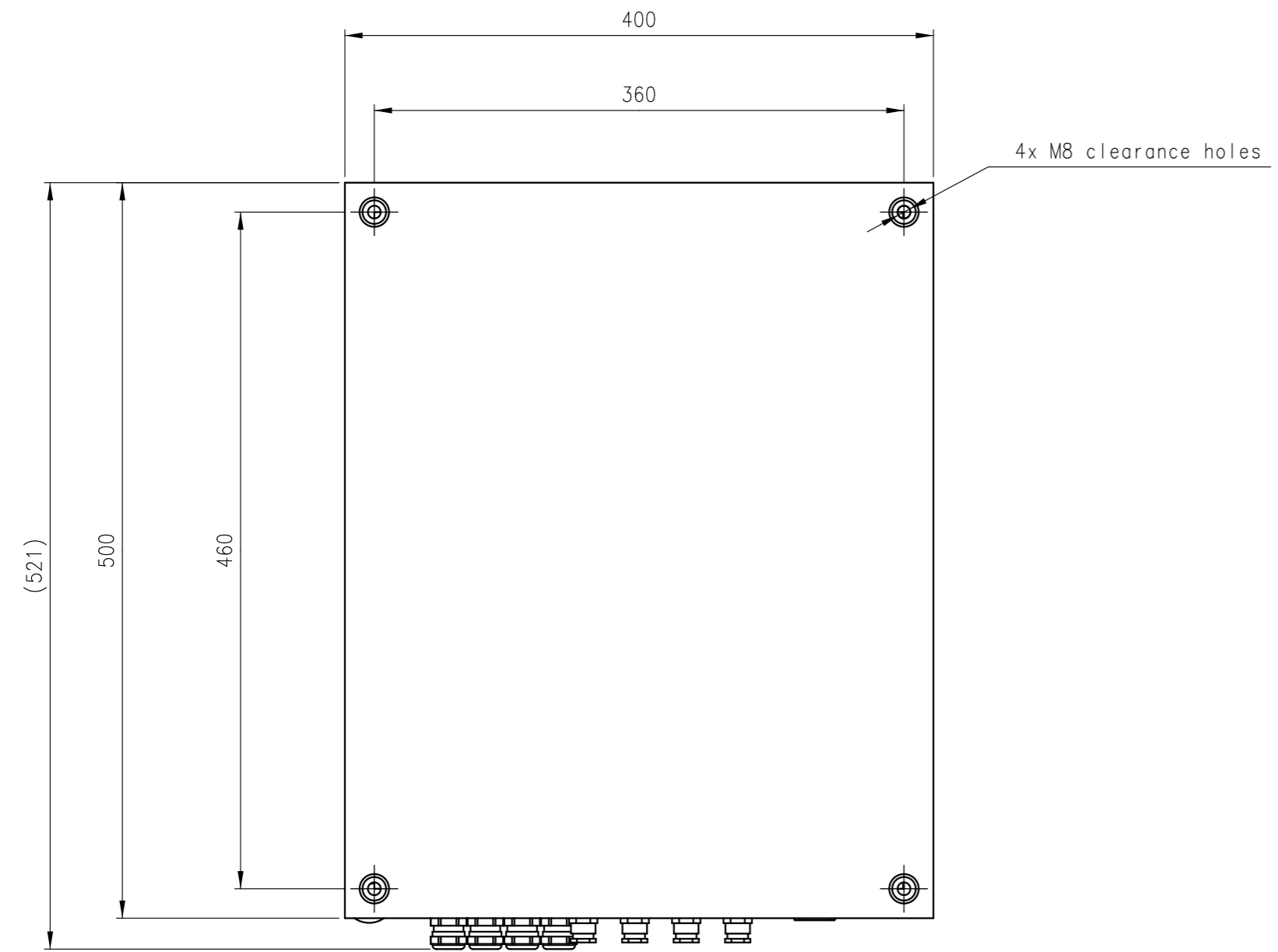

MATERIAL: -		UNLESS OTHERWISE STATED, TOLERANCES:		PROJ. METHODE	
SURFACE TREATMENT: -		DIM.: -		THREADS: - SURFACE: -	
Outline Dimensions		SCALE		 Kongsberg Maritime AS KONGSBERG	
Cabinet		1:4			
SU 30		ALTERNATIVE SCALE		REV. Pro01	
ORIGIN DATE		CLASS. CODE		ITEM ID	
2008.05.16		951		Sketch	
DESIGNED		APPROVED		REV. DATE.	
HF				2008.05.16	
SIZE		SHEET			
A2		1 OF 1			

©2009 Kongsberg Maritime

Kongsberg Maritime AS

Strandpromenaden 50
P.O.Box 111
N-3191 Horten,
Norway

Telephone: +47 33 02 38 00
Telefax: +47 33 04 47 53
www.kongsberg.com
subsea@kongsberg.com



KONGSBERG