

Mini-manual

Simrad SP60

Low frequency fish finding sonar

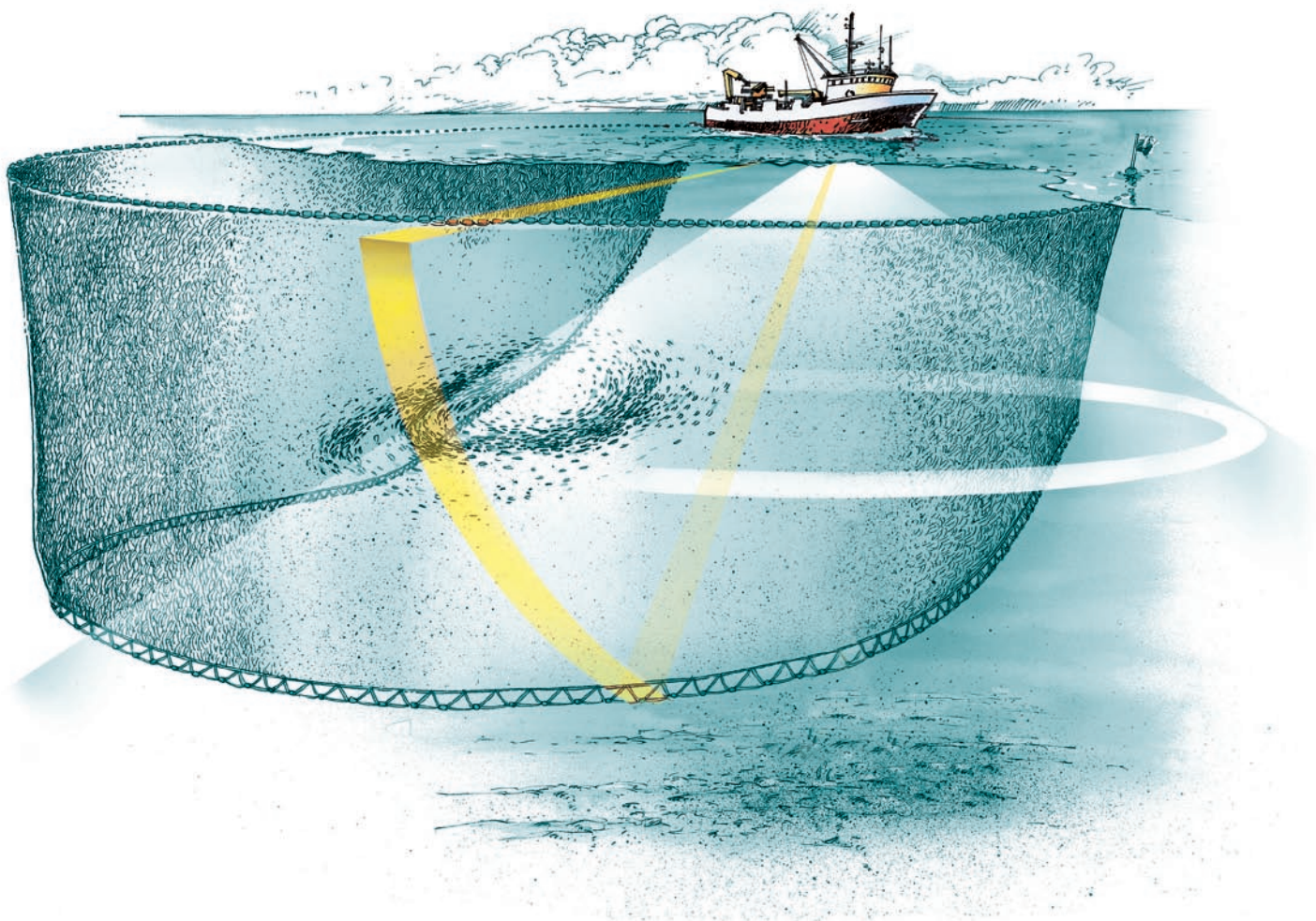

Simrad SP60

Mini-manual

This manual provides you with the basic information required to operate the Simrad SP60 Low frequency fish finding sonar. For more detailed information, refer to the *Operator manual*.

Document history

Document number: 300065 / ISBN-10: 82-8066-069-0 / ISBN-13: 978-82-8066-069-5		
Rev. A	March 2006	First version.

Copyright

©2006 Simrad AS

Disclaimer

The information contained in this document remains the sole property of Simrad AS. No part of this document may be copied or reproduced in any form or by any means, and the information contained within it is not to be communicated to a third party, without the prior written consent of Simrad AS. Simrad AS endeavours to ensure that all information in this document is correct and fairly stated, but does not accept liability for any errors or omissions.

Warning

The equipment to which this manual applies must only be used for the purpose for which it was designed. Improper use or maintenance may cause damage to the equipment and/or injury to personnel. The user must be familiar with the contents of the appropriate manuals before attempting to operate or work on the equipment. Simrad disclaims any responsibility for damage or injury caused by improper installation, use or maintenance of the equipment.

Support

If you require maintenance on your Simrad equipment, contact your local dealer. You can also contact Simrad using the following e-mail address: contact@simrad.com

Simrad AS

Strandpromenaden 50
P.O.Box 111
N-3191 Horten,
Norway

Telephone: +47 33 03 40 00
Telefax: +47 33 04 29 87
www.simrad.com
simrad.sales@simrad.com

SIMRAD
A KONGSBERG Company

Table of contents

INTRODUCTION	5
IMPORTANT MATTERS	6
RELEASES	7
SP60 Release history	7
POWER ON/OFF	8
How to switch on the sonar	8
How to switch off the sonar.....	9
SONAR CONTROL PANEL	10
OPERATIONAL MODES	12
USING THE MENUS.....	14
Menu structure.....	14
Menu buttons	15
How to hide the menu	16
Horizontal menu	16
Vertical menu.....	17
Display menu.....	18
Setup menu	19
COMMON PROCEDURES	21
Menu procedures	21
How to hide the menu	21
How to simplify the menu	21
Gain adjustment procedures	21
How to adjust the gain.....	22
How to control the AGC.....	22
How to control the RCG.....	22
How to control the TVG.....	23
How to control the Display gain.....	23
Mode procedures	24
How to select operational mode	24
How to define the function of the Mode buttons.....	24
How to sort the operational modes	24
Storage procedures	25
How to store sonar images.....	25
How to recall sonar images.....	25
How to keep sonar images	26
How to delete sonar images	27
How to rename sonar images	27

How to print sonar images	27
How to burn sonar images on a CD	28
Automatic search and tracking procedures	29
How to start the horizontal search program	29
How to start the vertical search program.....	29
How to enable position track	30
How to enable target track.....	30
How to add a target tracking line.....	31
BASIC THEORY	32
Settings	32
TVG	32
AGC	33
PP Filter.....	33
Pulse form and length.....	33
Gain.....	33
RCG	34
Sector	34
Tilt.....	34
Noise and reverberation.....	35
Cavitation.....	36
Reverberation	36
Blocking	37
Check the noise yourself!	37
Layers and deflections	37
Temperature and salinity layers.....	38
Deflections	38

INTRODUCTION

The purpose of this booklet is to give you a short introduction to the operational use of the SP60 sonar. It is not possible to explain all the functionality and possibilities in detail, it is therefore important that you familiarize yourself with the operator manual provided with the sonar.

Know your sonar!

Your SP60 sonar is a large and expensive instrument. It is still relatively easy to operate once you get to know the menus and buttons. The sonar comprises the following units:

- A colour display monitor
- A computer (aka Sonar Processor Unit)
- A control panel (aka Sonar Control Panel)
- A transmitter- and receiver unit
- A hull unit with a transducer array

In this publication we will focus on the basic use of the display and control panel.

Click "Help"!

Installed on your SP60 sonar you will also find a comprehensive on-line help system. You may not be able to find your language, but everything written in the *SP60 Operator manual* is also available on the sonar display. When you click the **Help** button you will first see a small help text in a window below the menu. In this window you can click **Free** to open the complete manual. To close the manual, click the **Free** button at the lower left side of the large window.

But remember: When you open the complete on-line help manual, it will place itself on the top of the sonar picture!

IMPORTANT MATTERS

As with all advanced instruments, there are a few important matters about the SP60 that you must remember.

Before you switch on the sonar

When you power up the sonar, the transducer is lowered down below the vessel's hull. Make sure that you have sufficient water depth before you do this!

When the sonar is not in use

To protect the sonar when it is not in use, we strongly advise you to hoist the transducer, even though you may not switch off the power. In narrow or shallow waters this is very important, since you may - in worst case - run the transducer into the bottom. This will damage the transducer and the transducer shaft, and extensive repair is required.

When you dock the vessel

It is very important that the sonar system remains switched off when the vessel is in dry dock. If the transducer is subjected to transmit power when it is in open air, it will be damaged. As a safeguarding measure, you can remove the power fuses on the sonar system before the vessel is docked. As an extra safeguarding measure, the sonar is by default powered up with the transmit power switched off.

If something breaks down

If you think that something has been damaged on the sonar, contact your local dealer for advice.

RELEASES

The SP60 sonar is based on advanced software. We are continuously improving our products, and for this reason the sonar software is upgraded. New software versions will in most cases provide you with new functionality. To find out which software your sonar uses, click the **System** tab, then click **Test** in the menu, and finally **About**.

SP60 Release history

SW 1.2.X

3000 meter range added.

Ping sector can be set to Omni or Sector on the **Horizontal** menu.

Dead reckoning function implemented.

The **TX Power** function is changed to have the power switched off when the sonar is powered up.

The **Mode** buttons on control panel can be used to choose operational modes or operator setup.

The **PP Filter** has been improved.

SW 1.1.X.

When you select pulse form **FM Auto** the sonar will automatically remember the parameters you choose for short (less than 900 m) and long ranges (over 1200 m). When you switch between these ranges, the parameters you previously used will be retrieved.

User configurations can be stored and retrieved.

The **Fish alarm** function was added.

Dual 2 operational mode added.

Scientific output option implemented.

POWER ON/OFF

This chapter explains how to switch your sonar system on and off.

WARNING

Before you start: Make sure that the water depth below the keel is sufficient to lower the transducer!

How to switch on the sonar

Observe the following procedure.

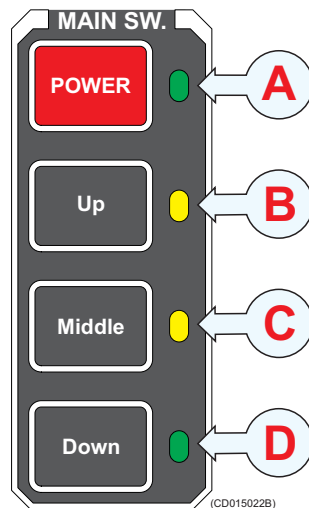

- 1 Press the **Power** button on the colour display monitor.
- 2 Press the **Power** button (A) on the Sonar Control Panel, and keep it depressed for approximately two seconds.
 - A green lamp will flash to indicate that the power has been switched on, and that the computer is starting up. After a short period (approximately 2 minutes) you will see the sonar picture on the display.
- 3 Press the **Down** button (D) on the control panel to lower the transducer.
 - The transducer will stop automatically when it has been lowered to its full length. The dialogue at the bottom right corner of the display will tell you when the transducer has been fully lowered.
 - By default the transmit power is disabled when the sonar is powered up. This is for safety reasons. In the menu, you will see that the **Transmit power** button flashes to remind you of this.
- 4 Set **Transmit power** to Full.

The **Middle** button is not used on the SP60 sonar.

How to switch off the sonar

Observe the following procedure.

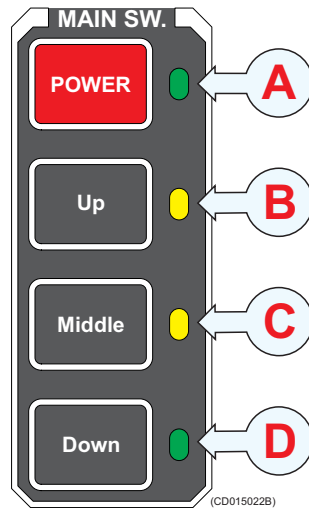

- 1 Press the **Up** button (B) on the Sonar Control Panel.
 - The transducer will automatically be hoisted, and it will stop when it has been fully retracted. The dialogue at the bottom right corner of the display will tell you when the transducer has been fully retracted.
- 2 Press the **Power** button (A) on the Sonar Control Panel, and keep it depressed for approximately two seconds.
 - The sonar is switched off. Note that you must NOT use the on/off switch on the computer, only this **Power** button on the Sonar Control Panel.
- 3 Switch off the display monitor.

If the sonar is switched off by mistake before the transducer has been hoisted, or you have problems with the electrical power, you can also hoist the transducer manually.

The **Middle** button is not used on the SP60 sonar.

SONAR CONTROL PANEL

The sonar control panel is organized into fields. The buttons within each field control a specific function on the sonar.

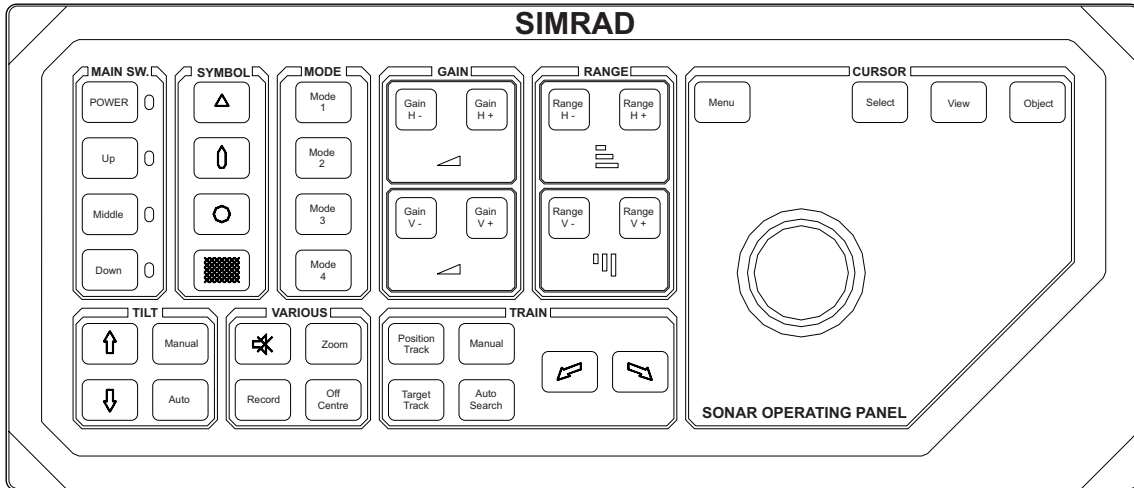

(CD015022A)

Main switch

This is the sonar's "on/off" switch. It has been previously explained.

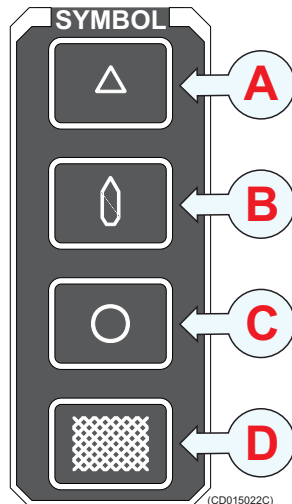

(CD015022C)

Symbol

These buttons allow you to enter four different markers on the sonar picture; **Target marker** (A), **Own ship** (B) and **Circle marker** (C). The markers will be placed at the cursor's location when you press the button. Every marker is identified with a number. You can study and remove the markers if you click the **Marker** tab. The last button (D) is used to deploy a seine or trawl symbol.

Mode

These four buttons provide fast access to the four operational modes you select, or to four pre-defined user configurations. You must select which four modes or user configurations to select, and in which order they shall appear. To choose button function, click **Mode** button on the **Display** menu. To define the order of the operational modes, click **Sort modes** on the **System** menu.

Gain

This is where you set up the gain in both horizontal and vertical plane.

Range

This is where you select horizontal and vertical range.

Cursor

The trackball is used to move the cursor on the display. The **Menu** button is used to hide the menu, while the **Select** button is used to make selections on the display. The **View** and **Object** buttons open specific short-cut menus.

Tilt

In this field you find the buttons used to tilt the sonar beam up or down. You can also start an automatic tilt program to carry out automatic searches.

Train

This field contains the button to control the sideways movements (training) of the sonar beam. You can also start an automatic training program to carry out automatic searches, and you can lock the beam on a chosen target or position.

Various

Here you can find buttons to disable the speaker, start a recording and to zoom in on the sonar picture.

OPERATIONAL MODES

The SP60 sonar provides you with several different display modes. These have been created to cover all your operational needs. Only the most common modes are described here.

Bow up

When **Bow up** is selected, the vessel symbol is stationary on the screen with the bow pointing upwards. The echo presentation covers 360 degrees around the vessel, and all echoes are updated for every ping. The distance from the vessel symbol to the outer echo ring is equal to the selected range.

270° /Vertical

The **270°/Vertical** mode is specially designed for purse seining. The vertical half slice is displayed in the lower left corner with the net on the starboard side. If the net is set on the port side, the 60 degrees vertical slice will be displayed in the lower right hand corner. With this presentation, you will find it easy to keep in contact with a school in both the vertical and horizontal presentation, and to determine its size distribution. The position of the school relative to the bottom is another important information provided by this presentation. The **Catch data** presentation for purse seining is shown on the right hand side (remove the menu!). It shows all the net data relative to the target and the bottom, as well as relevant target data.

Bow Up/Vertical

The **Bow up/Vertical** mode is specially designed for purse seining. The picture is divided into three sections; where the left side is a bow-up presentation. The upper part on the right hand side is a **Catch data** presentation (remove the menu!), while the lower part provides a vertical slice presentation.

North up

When **North Up** is selected, true north is always up on the screen. The vessel symbol is stationary with the bow pointing in the vessel's course direction. The movement of the echoes across the screen are controlled by a combination of the vessel's course and speed and the target's own movements.

True motion

When **True Motion** is selected, the picture is locked to a geographical position, where the vessel moves around the screen according to its present course and speed. All echoes are always presented in their correct position relative to the vessel, and their movements on the screen will be a true representation of the movements of the targets through the water. When the vessel

symbol reaches the edge of the screen, it will automatically be moved back to the centre, or to a position determined by the **Off Centre** button. This position is reset to the screen centre whenever the mode is changed. When you select **Target Track**, the target will automatically be moved to the screen centre.

Dual

The **Dual** modes are both kind of “two sonars in one” operation, where each presentation is updated for every second transmission. All settings can be set individually for each of the two presentations. This makes the dual mode especially useful if you wish to improve your settings, as you can compare the two presentations immediately.

USING THE MENUS

The SP60 sonar is equipped with an extensive menu system, and you will use this to choose operational modes and to control the functionality. In order to select active menu and to click the various buttons, you must use the cursor. The cursor is controlled by the trackball on the Sonar Control Panel, and to “click” you simply press the **Select** button.

Menu structure

The menu field on the SP60 sonar display contains several different buttons, tabs and parameter dialogues.

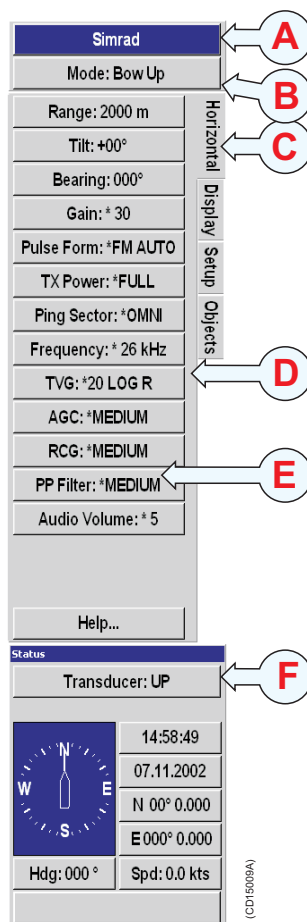

(A) Sonar type: The top field indicates the sonar in operation. This is not a button.

(B) Mode selection: This button is used to display the current mode. You can click it to select a different operational mode.

(C) Tabs: These selections on the right hand side of the menu allows you to choose between the menus applicable for the current operational mode. The menu field will provide different

tabs for each display mode. In order to select a new menu, move the cursor to the tab, and press the **Select** button on the Sonar Control Panel.

(D) Active menu: The next field contains the actual menu. Depending on operational mode and the menu properties, this menu can contain a number of buttons or other information.

(E) Menu button: Each menu button allows you to define the parameters for the specific function.

(F) Parameter dialogue: When a menu button is pushed, the applicable dialogue with a selection of parameters appears at the bottom of the menu.

Menu buttons

Each menu contains several buttons. Each button shows both the function and the current parameter. The majority of the buttons in each menu field have three functions.

- You can select a lower parameter value.
- You can select a higher parameter value.
- You can open the applicable parameter dialogue.

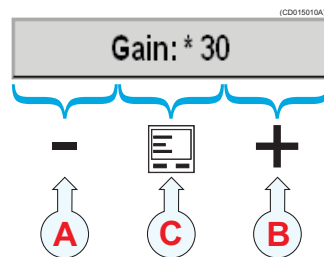

(A) Decrease: Position the cursor on the left side the button. Observe the arrow symbol change to a minus sign. Decrease the parameter by pressing the **Select** button on the Sonar Control Panel.

(B) Increase: Position the cursor on the right side the button. Observe the arrow symbol change to a plus sign. Increase the parameter by pressing the **Select** button on the Sonar Control Panel.

(C) Parameter dialogue: Position the cursor on the centre of the menu button. Observe the arrow symbol change to a menu symbol. Open the parameter dialogue by pressing the **Select** button on the Sonar Control Panel. The dialogue appears in the lower part of the menu field, providing an overview of the available options.

How to hide the menu

The menu is normally located on the right hand side of the display, but if you don't need it, you can easily remove it.

- 1 Press the **Menu** button on the Sonar Control Panel.

The **Menu** button will act as a toggle switch. Press once to remove the menu, and one more time to retrieve it.

You can also use an alternative method:

- 1 Press the **Display** tab.
- 2 Click the **Full screen: Off** button.

In order to restore the previous menu location:

- 1 Move the cursor to the far left or far right side of the display
- 2 Observe that the menu appear.
- 3 Click the **Full screen: On** button.

Horizontal menu

The **Horizontal** menu is used to control the horizontal presentations. The parameters chosen are present in all display modes. When a horizontal parameter setting is selected and defined in one mode, the chosen settings will automatically be applied to all modes.

- **Range:** Select the current range.
- **Tilt:** Select the sonar beam's vertical angle.
- **Bearing:** Add a white bearing line to your sonar picture.
- **Gain:** This setting controls the amplification of the received echoes.
- **Pulse form:** The standard pulse form is **FM Auto**. If you experience a lot of reverberation from the bottom, decrease the pulse length. In good water conditions while searching for scattered fish, you may well use setting **CW Long**.
- **TX Power:** This button controls the transmission power.
- **Sector:** Use **Omni** to transmit in 360 degrees, or **Sector** to transmit a single beam.
- **Frequency:** On the SP60 you can alter the sonar's transmission frequency. This is very useful if you have other vessels in the vicinity. Remember that lower frequencies will increase the range of your sonar, but also give you a wider beam.
- **TVG:** Time Varied Gain. This function will automatically adjust the gain in the sonar to compensate for geometric spread and absorption.

- **AGC:** Automatic Gain Control. This function will automatically reduce the gain if you experience reverberation and noise, or increase it if the conditions permit it. Using the AGC will ensure best possible signal processing.
- **RCG:** Reverberation Controlled Gain. This function will automatically remove unwanted reverberation from the bottom or from the sea surface. It may however also remove scattered fish.
- **PP Filter:** The Ping-to-Ping filter will only show you the echoes if they are still present after several consecutive pings (2, 4 or 8). This function will provide you with a more stable echo presentation, as spurious echoes will disappear.
- **Audio Volume:** This button allows you to control the audio level in the loudspeaker.

Vertical menu

The **Vertical** menu is only shown in modes with a vertical slice function. All relevant settings, except the **TX Power**, can be selected separately for the vertical modes independent of the horizontal settings. When any vertical setting is selected and defined in one mode, the setting will be applied to all vertical modes.

- **Range:** Select the current range.
- **Bearing:** Use this function to adjust the bearing of the white audio channel line.
- **Gain:** This is the analogue gain. If you activate the **AGC** function, this gain setting is ignored.
- **Pulse form:** The standard pulse form is **FM Auto**. If you experience a lot of reverberation from the bottom, decrease the pulse length. In good water conditions while searching for scattered fish, you may well use setting **CW Long**.
- **TX Power:** This button controls the transmission power.
- **Frequency:** On the SP60 you can alter the sonar's transmission frequency. This is very useful if you have other vessels in the vicinity. Remember that lower frequencies will increase the range of your sonar, but also give you a wider beam.
- **TVG:** Time Varied Gain. This function will automatically adjust the gain in the sonar to compensate for geometric spread and absorption. Note that the TVG will only work on ranges below 1500 meters.
- **AGC:** Automatic Gain Control. This function will automatically reduce the gain if you experience reverberation and noise, or increase it if the conditions permit it. Using the AGC will ensure best possible signal processing.

- **RCG:** Reverberation Controlled Gain. This function will automatically remove unwanted reverberation from the bottom or from the sea surface. It may however also remove scattered fish.
- **PP Filter:** The Ping-to-Ping filter will only show you the echoes if they are still present after several consecutive pings (2, 4 or 8). This function will provide you with a more stable echo presentation, as spurious echoes will disappear.
- **Audio Volume:** This button allows you to control the audio level in the loudspeaker.

Display menu

The **Display** menu is shown in all display modes, and provides access to parameters controlling the visual presentation of the sonar views. Some of the choices on the menu are simple on/off buttons.

- **Full screen:** Click this button to remove or retrieve the menu.
- **Audio mute:** Click this button to mute the loudspeaker.
- **Resolution:** Select 16 or 64 colours in the display presentation. The chosen resolution is shown in the colour bar below the button.
- **Display gain:** This function controls the amount of echo that are displayed. Use this control together with **Gain** to control the sonar's sensitivity.
- **Colour threshold:** Click this button to control how many colours to use in the echo presentation.
- **Colours:** Control how bright colours you wish to use.
- **Panel backlight:** This function controls the intensity of the back light in the Sonar Control Panel.
- **Mode buttons:** Use this button to choose how the **Mode** buttons on the Sonar Control Panel shall work. You can either choose between the four most frequent modes, or the four most frequent user settings.
- **Language:** Choose menu language.
- **Units:** Allows you to choose the units used by the sonar.
- **Cosmetics:** Click to access the **Cosmetics** menu, which allows you to control the amount of support information on the sonar picture.
- **Bearing:** Set up the sound channel bearing to be relative or related to true north.
- **Menu:** Choose if you wish to see the complete menus (as described here), or just the most important settings.

Setup menu

The **Setup** menu is shown in all display modes, and gives access to parameters controlling the processing and algorithms in the sonar system. It also provides access to specific system parameters and functions such as **Test** and **Store/Recall**.

- **Store/Recall:** Click this button to record and playback sonar images.
- **Test:** Click this button to access the sonar's test software. These utilities are only provided for certified service technicians, and they are not documented.
- **Gear:** This button is used to select the type of fishing gear you use, and to get the right size and position of the gear on the display.
- **School:** This parameter is used to obtain information of the volume estimation of a school in the automatic target tracking program.
- **Dead reckoning:** This function is used to improve the position of the historical track line from the vessel, relative to the actual position of the drifting fishing gear.
- **Stabilizer:** When this function is active, the sonar will automatically adjust the sonar picture to compensate for the ship's movements in the sea.
- **Movements:** This function makes it possible to estimate the position of a tracked school at a given time.
- **Track window:** This command enables you to adjust the size of the window the sonar places on the chosen target. A larger track window will enable the system to track a large target more easily, but the system will be more susceptible to background noise. Smaller targets may be ignored if there is a lot of noise in the area, as the system will track the strongest echo within the track window.
- **Wind direction:** The wind marker is show in the outer area of the echo presentation as a white arrow. This arrow can be manually adjusted for indication of the wind or current direction, or automatically show the wind direction if a wind sensor is connected.
- **Wind speed:** This is not a parameter. It is only a read-out of the current wind speed providing that a wind sensor is connected.
- **Sort modes:** Click to access the **Sort Modes** menu. This menu is used to select the display modes to be activated by the four **Mode** buttons on the Sonar Operating Panel. The four upper display modes in this menu will always be the four modes provided by the four **Mode** buttons in the order they are sorted.

- **External sync:** This function makes it possible to eliminate interference from other Simrad sonars on board your vessel. If the sonars are connected together, you can use these settings to synchronise their transmissions.
- **Scientific output:** This is an optional functionality designed to be used when the sonar is used for scientific purposes. When enabled, the sonar will provide special information on an ethernet port.
- **Fish alarm:** This function makes it possible to set up the sonar to warn you when a school of fish are detected inside the selected sector. The selected sector is displayed with white dashed lines in the horizontal sonar picture.
- **User setting:** This function is used to store the parameter settings for different type of fisheries, or individual user related settings.
- **Default setting:** Click this button to retrieve the factory settings.

COMMON PROCEDURES

This chapter presents how to perform the most common procedures on the SP60 sonar. Note that the “power on/off” procedures have been previously explained.

Menu procedures

This section provides general procedures for menu handling.

How to hide the menu

The menu is normally located on the right hand side of the display, but if you don't need it, you can easily remove it.

- 1 Press the **Menu** button on the Sonar Control Panel.

The **Menu** button will act as a toggle switch. Press once to remove the menu, and one more time to retrieve it.

You can also use an alternative method:

- 1 Press the **Display** tab.
- 2 Click the **Full screen: Off** button.

In order to restore the previous menu location:

- 1 Move the cursor to the far left or far right side of the display
- 2 Observe that the menu appear.
- 3 Click the **Full screen: On** button.

How to simplify the menu

You can easily reduce the number of buttons on the sonar menus. This can be useful if you never use them.

- 1 Press the **Display** tab to open the menu.
- 2 Click the **Menu** button at the bottom of the **Display** menu.
 - Click the left side of the button to scroll down the list of settings.
 - Click the right side of the button to scroll up the list of settings.
 - Click the middle of the button to open the parameter dialogue (recommended).
- 3 In the parameter dialogue, select the menu level you wish to use.

Gain adjustment procedures

This section explains how to control the manual and automatic gain settings on the SP60 sonar.

How to adjust the gain

You can adjust the sonar gain by means of the control buttons on the Sonar Control Panel, or by using the **Gain** button on the **Horizontal** and **Vertical** menus.

Using the Sonar Control Panel:

- 1 Locate the **Gain** field on the Sonar Control Panel.
- 2 Press the **Gain H+** or **Gain H-** to increase or decrease the horizontal gain.
- 3 Press the **Gain V+** or **Gain V-** to increase or decrease the vertical gain.

Using the menu system:

- 1 Click the **Horizontal** or **Vertical** tab to open the respective menu.
- 2 Click the **Gain** button to adjust the gain.
 - Click the left side of the button to decrease the gain.
 - Click the right side of the button to increase the gain.
 - Click the middle of the button to open the parameter dialogue.

How to control the AGC

The **AGC** (Automatic Gain Control) adjusts the gain in the sonar's preamplifier circuitry. This gain depends on the strength of the incoming echo signal. The result is a filter effect, reducing noise and reverberation. The **AGC** has four different settings.

- 1 Click the **Horizontal** or **Vertical** tab to open the respective menu.
- 2 Click the **AGC** button to adjust the parameter.
 - Click the left side of the button to decrease the parameter value.
 - Click the right side of the button to increase the parameter value.
 - Click the middle of the button to open the parameter dialogue.

How to control the RCG

The **RCG** (Reverberation Controlled Gain) regulates the receiver gain individually for each of the receiving beams. If you select **Weak** and **Medium**, echoes from propellers, surface and bottom reverberations will be suppressed, while target echoes will remain in view. If you select **Strong**, a special filter removes the bottom, while echoes on the bottom will be presented.

Note

Scattered fish can be perceived as reverberation. The RCG function should therefore be used with care if scattered schools are to be detected.

- 1 Click the **Horizontal** or **Vertical** tab to open the respective menu.
- 2 Click the **RCG** button to adjust the parameter.
 - Click the left side of the button to decrease the parameter value.
 - Click the right side of the button to increase the parameter value.
 - Click the middle of the button to open the parameter dialogue.

How to control the TVG

The **TVG** (Time Varied Gain) controls the gain in the signal amplifier. The gain is weakest just after the ping, and increases in accordance with time (and therefore range). A number of standard gain curves are available, as well as **Off** and **Auto**. By using TVG, the gain is adjusted in such way that a school of fish with a certain size and density will be presented with approximately the same strength on the screen in any position inside the regulated TVG range.

- 1 Click the **Horizontal** or **Vertical** tab to open the respective menu.
- 2 Click the **TVG** button to adjust the parameter.
 - Click the left side of the button to decrease the parameter value.
 - Click the right side of the button to increase the parameter value.
 - Click the middle of the button to open the parameter dialogue.

How to control the Display gain

The **Display Gain** increases or decreases the presentation of the echo colours on the display.

- 1 Click the **Display** tab to open the menu.
- 2 Click the **Display gain** button to adjust the parameter.
 - Click the left side of the button to decrease the parameter value.
 - Click the right side of the button to increase the parameter value.

- Click the middle of the button to open the parameter dialogue.

Mode procedures

This section explains how to choose operational modes, and how to set up the **Mode** buttons on the SP60 Sonar Control Unit.

How to select operational mode

Your SP60 sonar is equipped with several operational modes. Observe these procedures to choose the mode best fit for your current operations.

Using the Sonar Control Panel:

- 1 Locate the **Mode** field on your Sonar Control Panel
- 2 Press one of the four buttons to choose mode.

You can only choose from four different modes using these buttons, but you can decide which modes these are.

Using the menu system:

- 1 Locate the **Mode** button on the top of each menu.
- 2 Click the **Mode** button to choose operational mode.
 - Click the left side of the button to scroll down the list of available modes.
 - Click the right side of the button to scroll up the list of available modes.
 - Click the middle of the button to open the parameter dialogue for direct access to the requested mode.

How to define the function of the Mode buttons

The **Mode** buttons on your SP60 Sonar Control Panel can either be used to select operational mode, or user settings. To switch between these options, observe the procedure.

- 1 Click the **Display** tab to open the menu.
- 2 Click the **Mode Buttons:** button to select **Mode** or **User**.

How to sort the operational modes

Your SP60 sonar provides you with a selection of operational modes. This list of modes can be sorted to suit your preferences. The top four modes on your list can be accessed by pressing the four **Mode** buttons on the Sonar Control Panel. To sort the modes, observe the procedure.

- 1 Click the **Setup** tab to open the menu.

- 2 Click the **Sort Modes** button to open the **Sort Modes** menu.
 - The **Sort Modes** menu lists all the available modes in their current order.
- 3 Click one of the operational modes.
 - Observe that the **Move down** and/or **Move up** buttons at the bottom of the menu are activated.
- 4 Click the **Move down** and/or **Move up** buttons to move the chosen operational mode up or down the list.
- 5 When the list has been arranged in the order you wish to keep, click the **Close** button.
 - The current order is saved automatically.

Storage procedures

This section explains how to store and recall sonar images on the SP60.

How to store sonar images

Observe the following procedure to store one or more sonar images.

- 1 Click the **Setup** tab to open the menu.
- 2 Click the **Store/Recall** button to open the **Store/Recall** menu.
- 3 Click the **Store mode** button to choose mode.
 - Click the left side of the button to scroll down the list of options.
 - Click the right side of the button to scroll up the list of options.
 - Click the middle of the button to open the parameter dialogue for direct access to the requested setting.
- 4 Click the **Store** button.
- 5 When all images have been stored, click the **Close** button to close the **Store/Recall** menu.

Once the **Store** has been activated, the sonar will save sonar images as defined by the **Store mode** setting. Each image is added to the list of temporary files located below the buttons. Each file name reflects the date and time.

How to recall sonar images

Observe the following procedure to recall sonar images.

To access the menu:

- 1 Click the **Setup** tab to open the menu.
- 2 Click the **Store/Recall** button to open the **Store/Recall** menu.

- 3 Observe the list of images in the **Store/Recall** menu.

To recall a single image:

- 1 Click the **Recall mode** button, and select **Single shot**.
- 2 Click one of the images to select it.
- 3 Click the **Recall** button to view the image.
 - The chosen image will be displayed. The phrase “RECALL” is used to indicate that a recalled image has replaced the sonar image.
- 4 Click the **Object** button on the Sonar Control Panel to restore normal operation.

To recall several images:

- 1 Click the **Recall mode** button, and select how long time you wish to see each image.
- 2 To select a number of images files, click the top file, then hold the **Select** button on the Sonar Control Panel depressed while you move the cursor down to select the other files in the field.
- 3 Click the **Recall** button to view the images.
 - The chosen images will be displayed, one by one. The phrase “RECALL” is used to indicate that a recalled image has replaced the sonar image.
 - When all images has been displayed, the sonar will automatically resume normal operation.

How to keep sonar images

When you store new sonar images, they will by default be added to the list of **Temporary files**. This list will contain maximum 100 images, and when this limit has been reached, the oldest files will be automatically removed. Observe the following procedure to keep selected sonar images from being deleted.

- 1 Click the **Setup** tab to open the menu.
- 2 Click the **Store/Recall** button to open the **Store/Recall** menu.
- 3 Observe the list of images in the **Store/Recall** menu.
- 4 Click one of the images in the **Temporary files** field to select it.
- 5 Click the arrow on the top of the **Permanent files** field to move the selected image down.

The **Permanent files** list does not limit the number of files it can contain. This is however limited by the physical size of the hard disk in the Sonar Processing Unit.

How to delete sonar images

Observe the following procedure to delete selected sonar images.

- 1 Click the **Setup** tab to open the menu.
- 2 Click the **Store/Recall** button to open the **Store/Recall** menu.
- 3 Observe the list of images in the **Store/Recall** menu.
- 4 Click one of the images to select it.
- 5 Click the **Delete** button at the bottom of the file fields to delete the selected image.

How to rename sonar images

Observe the following procedure to print selected sonar images.

- 1 Click the **Setup** tab to open the menu.
- 2 Click the **Store/Recall** button to open the **Store/Recall** menu.
- 3 Observe the list of images in the **Store/Recall** menu.
- 4 Click one of the images in the **Permanent files** field to select it.
- 5 Click the **Rename** button below the files to rename the selected image.
 - Observe that a parameter dialogue opens to present the current file name.
 - Observe that an on-line keyboard opens to allow you to enter characters.
- 6 Place the cursor at the beginning of the current file name, and click the **Del** (Delete) button on the on-line keyboard to remove the characters in the current file name.
 - Make sure that you do not delete the file name extension **.bmp**.
- 7 Click the necessary characters on the on-line keyboard to build a new file name.
- 8 Click the **Close** button in the parameter dialogue when you have completed the new file name.

You are also permitted to change the file name on images in the **Temporary files** field. However, if you wish to transfer the chosen image to the **Permanent files** field afterwards, you will find that the new file name is changed by the transfer process.

How to print sonar images

Observe the following procedure to print selected sonar images.

- 1 Click the **Setup** tab to open the menu.
- 2 Click the **Store/Recall** button to open the **Store/Recall** menu.
- 3 Observe the list of images in the **Store/Recall** menu.

- 4 Click one of the images to select it.
- 5 Click the **Print** button below the files to print the selected image.

The image will be sent to the default printer connected to the Sonar Processing Unit. You are not allowed to control the output size and format.

How to burn sonar images on a CD

The SP60 Sonar Processing Unit is provided with a CD player capable of burning blank CDs. Observe the following procedure to burn selected sonar images on a blank CD.

- 1 Insert a blank recordable CD in the Sonar Processing Unit.
- 2 Click the **Setup** tab to open the menu.
- 3 Click the **Store/Recall** button to open the **Store/Recall** menu.
- 4 Observe the list of images in the **Store/Recall** menu.
- 5 Click any image file to select it.
- 6 Click the **Rename** button below the files to rename the selected image.
 - Observe that a parameter dialogue opens to present the current file name.
 - Observe that an on-line keyboard opens to allow you to enter characters.
- 7 On the on-line keyboard, double-click on the four-coloured **Windows** button next to the spacebar.
 - Observe that the standard Windows® **Taskbar** appears, and that the **Start** menu is shown in the lower left corner of the display.
- 8 On the on-line keyboard, click once on the four-coloured **Windows** button.
- 9 Observe that the **Start** menu is removed, and that the **Taskbar** is still shown.
- 10 Press and hold the **Object** button on the Sonar Control Panel depressed, and click the **Start** button on the **Taskbar**.
- 11 On the menu that appears, choose **Explore**.
- 12 Locate the CD drive in the explorer window, and locate the image files you wish to burn.
 - The image files are located in the folder *d:/winson/screendumps*.
- 13 Select the files you wish to burn, and drag them over to the CD drive.
- 14 Allow the CD burner to burn the disc.

- 15 Select the CD drive. Hold the **Object** button depressed, click, and select **Finalize**.
- 16 Allow the CD burner to finalize the disc.
- 17 Remove the CD from the drive. Close the explorer window and the on-line keyboard, and close all open parameter dialogues and menus.

Automatic search and tracking procedures

The SP60 sonar provides you with two automatic search programs, horizontal and vertical. Both are initiated from the Sonar Control Unit

How to start the horizontal search program

Observe the following procedure to run the automatic search program.

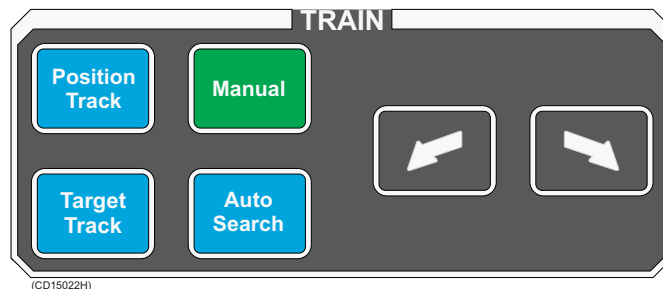

- 1 Press the **Auto search** button in the **Train** field on the Sonar Control Panel to start the horizontal search program.
- 2 Hold the **Auto search** button depressed while you also press one of the two “**arrow**” buttons in the **Train** field.
- 3 Observe that the opening angle of the search sector is adjusted accordingly.
- 4 Press and hold one of the two “**arrow**” buttons.
- 5 Observe that the centre of the search sector is trained accordingly.

To exit the search program, press the **Manual** button.

How to start the vertical search program

Observe the following procedure to run the automatic search program.

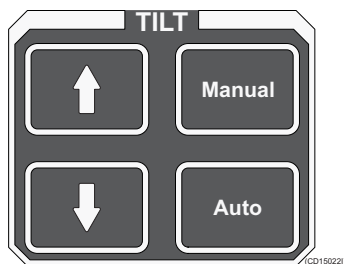

- 1 Press the **Auto** button in the **Tilt** field on the Sonar Control Panel to start the vertical search program.
- 2 Hold the **Auto** button depressed while you also press one of the two “**arrow**” buttons in the **Tilt** field.
- 3 Observe that the vertical opening angle of the search sector is adjusted accordingly.
- 4 Press and hold one of the two “**arrow**” buttons.
- 5 Observe that the centre of the vertical search sector is adjusted accordingly.

To exit the search program, press the **Manual** button.

How to enable position track

Observe this procedure to initiate a position track.

- 1 Place the cursor over the desired location.
- 2 Press the **Position track** button in the **Train** field on the Sonar Control Panel.

A geographically fixed circle will appear on the display, and its position will automatically be tracked by the system with respect to the bearing and tilt angle. The track parameters can be investigated by accessing the **Objects** menu. When the **Auto Tilt** function is activated in the **Position Track** mode the tilt search centre is automatically adjusted with regard to the distance to the tracked position.

How to enable target track

Observe this procedure to initiate a target track.

- 1 Place the cursor over the desired target.
- 2 Press the **Target track** button in the **Train** field on the Sonar Control Panel.

A circle will appear on the display and its position automatically tracked by the system using the strongest echo centred in the "window" represented by two lines on the audio line. The "window's" size may be selected by the **Track Window** button in the **Setup** menu.

The vector originating from the target's centre indicates its course and speed. The length of the vector increases relative to the target's speed. One knot is represented by a small mark on the vector. A course line can also be displayed showing the target's track. Target tracking symbols and data are displayed with a light violet colour.

How to add a target tracking line

Observe this procedure to add a tracking line to a tracked target to indicate its movement history.

- 1** Choose an operational mode with a horizontal view.
- 2** Press the **View** button in the **Cursor** field on the Sonar Control Panel.
- 3** Observe that the **GeoView** short-cut menu appears on the display.
- 4** Click the **Target track** option on the menu.
- 5** Observe that the **Target track** parameter dialogue opens below the menu.
- 6** Choose the length of the tracking line, and click **Close** to exit.

BASIC THEORY

This chapter explains some of the basic theory related to settings, error sources and noise conditions.

Settings

A sonar will transmit a sound wave into the water around the vessel. When this sound wave hits fish, bottom, or other objects in the water, a part of the sound will be returned as echoes. These echoes are collected by the sonar, interpreted by the sonar computers, and presented on the display.

The most important interpretation is however left to you, and it may often be difficult to distinguish the echoes and identify targets. In order to help you with this, the SP60 sonar provides numerous advanced filter and gain functions. You can also tilt the sonar beam vertically in order to achieve an optimum result, and you can use the sonar's vertical slice to view "across" into the water.

This chapter provides you with some basic theory about some of the key settings available.

TVG

TVG means "Time Varied Gain". As echoes will be weaker when the distance to them increase, the sonar will automatically amplify distant echoes more than close echoes. In practice, the gain will increase in proportion with how long the sonar must wait for the echoes.

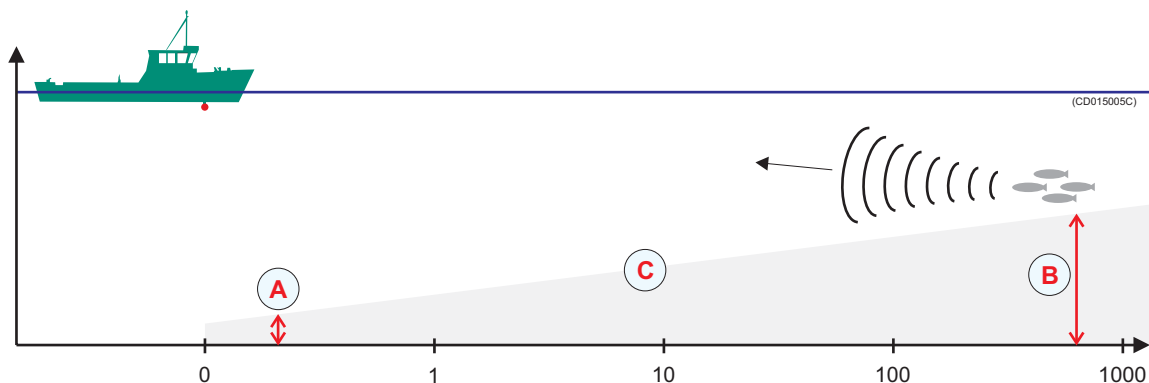

The drawing illustrates the TVG principle: The gain at time (B) is larger than at time (A).

When you choose the TVG setting you can either switch it off, or choose a "X log R" value. The different settings determine how much gain the sonar will use as time elapses along the X-axis. A higher value for "X" will make the angle (C) steeper.

Default setting on the SP60 sonar is **20 log R**.

AGC

AGC means “Automatic Gain Control”. If you wish the SP60 sonar to control its own gain automatically, you must enable this function. You can choose from three different levels. When the AGC has been switched on, the manual **Gain** setting you have chosen will only work on shorter ranges. Once the range is increased, the computer will gradually take control over the sonar gain.

Default setting on the SP60 sonar is **Medium**.

PP Filter

PP Filter means “Ping-to-Ping Filter”. When this function is activated, the sonar will compare the echoes from one ping with the echoes from the next pings. If an echo is present at the first ping, but then disappears at the next, the sonar will interpret this as noise and reverberation, and remove it.

If you choose setting **Weak**, the sonar will only compare two consecutive pings. If you choose settings **Medium** or **Strong** the sonar will compare four and eight pings respectively.

Default setting on the SP60 sonar is **Medium**.

Pulse form and length

On the SP60 sonar, you can transmit sound modulated as FM or CW.

FM means “frequency modulated”, which means that the frequency of the transmitted pulse is changed during the transmission. In most cases this method will provide better echo presentation and stability, and you will avoid excessive noise and reverberation.

Default setting on the SP60 sonar is **FM Auto**. In this transmission mode, the sonar will automatically choose from a set of different frequencies depending on the current range.

CW means “continuous wave”, which means that the transmission frequency is fixed during the entire pulse. When you use CW transmission you can choose the length of the pulses. In a search phase under good conditions, you should try setting **Long**. If the conditions worsen, try to shorten the pulse length. This will make it easier to distinguish the various echoes, and the reverberation will be reduced.

Gain

You can adjust the gain in many different ways, but the most important is the setting made by the **Gain** on the **Horizontal** and **Vertical** menus.

If you have too much gain, you will see a sonar picture with too many echoes. This is because the large amplification presents all kind of noise and reverberation that the sonar picks up. If the gain is smaller the noise and reverberation will disappear, but if it is too small the fish echoes may disappear as well. In most cases you should try with a medium value. On the SP60 sonar, the default value is set to **30**.

RCG

RCG means “Reverberation Controlled Gain”. This function compare the strength from each echo, and then automatically adjust the range and echo level in the sonar picture.

The RCG will remove unwanted echoes from the sea surface and the bottom. If you select setting **Strong** the bottom echoes will disappear altogether if the bottom is flat, while schools of fish close to the bottom will be easier to see.

Note that scattered fish may be more difficult to spot if the RCG function is active, as these can be misinterpreted as reverberation. It is therefore important that you use the RCG with great care if your are searching for scattered fish.

Default setting on the SP60 sonar is **Medium**.

Sector

The SP60 sonar can transmit the sound in two shapes; **Omni** or **Sector**.

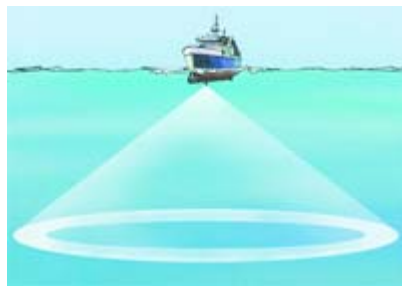

An Omni transmission means that the sound is transmitted in a full 360 degrees circle around the vessel, while Sector means that it is transmitted in a defined direction shaped like a cone. The Sector transmission will provide you with a longer range.

Tilt

The sonar beam can be tilted vertically in steps of 1 degree, and the chosen tilt is shown on the sonar picture. At 0 degrees tilt you will transmit the sonar beam in parallel with the sea surface, while 90 degrees tilt will direct it straight down.

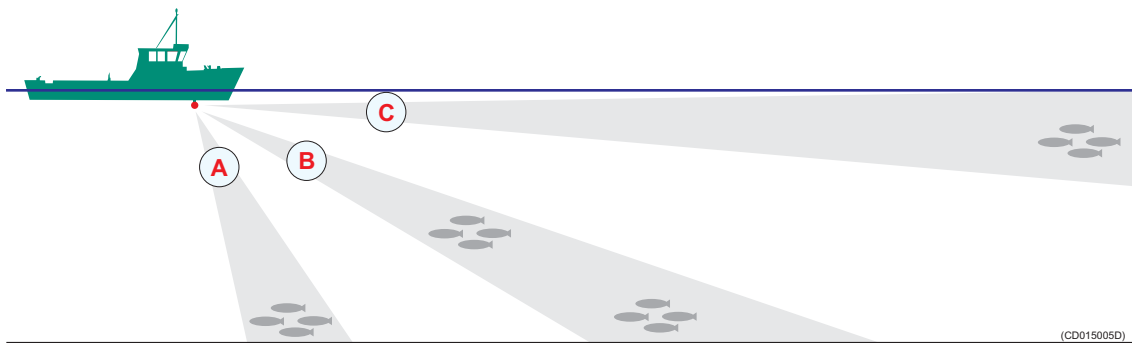

The challenge will always be to find a tilt that prevents the fish echoes to be buried in reverberation and bottom echoes.

If you use a steep tilt (A) the fish will easily be disguised by the bottom echoes, but a strong RCG setting will help. As the distance from the bottom to the fish increases, the fish will be easier to see when the RCG removes the bottom echoes. However, this assumes that the fish echoes are considerably stronger than the bottom echoes.

If you use a very small tilt (C) you will not be bothered by bottom echoes. If the sea surface is gusty, you will however easily see echoes from the waves. These echoes will normally be rather weak, and will hardly move in relation to your vessel.

By means of a medium tilt angle (B) you will most likely be able to pick up scattered fish or schools if these are located at some distance above the bottom. The upper school in the illustration will appear on the sonar picture before the bottom echo, while the lower school will easily be disguised by the bottom echoes. Once again you can activate the RCG function to improve the reading.

Noise and reverberation

Every time you use the sonar the quality of your search operations will depend on numerous error sources caused by the natural environment and physical properties of your vessel. We distinguish between the two terms *noise* and *reverberation*.

- *Noise* is generated by the vessel: engine, propellers, winches, refrigerating plants etc.
- *Reverberation* is caused by natural conditions in the sea: temperature, salinity, sea state and bottom conditions.

The most common cause of acoustic noise is the propeller and the cavitation caused by its rotation. Other typical noise sources on board your vessels are winches, refrigerating plants, power generators, pumps and cranes. If you experience problems you think are caused by noise, try to find out which system that causes the noise, and contact your dealer for advice.

Cavitation

As the propeller blades move through the water, low pressure areas are formed as the water accelerates around and moves past the blades. The faster the blades move, the lower the pressure around it will become. As it reaches vapour pressure, the water vaporizes and forms small bubbles of gas. This is cavitation. When the bubbles collapse, they cause very strong local shock-waves in the water. These may be audible and can also damage the propeller blades. In addition to this, the cavitation will generate very strong reverberation, commonly seen as a red stripe of echoes behind the vessel.

If you have big problems with cavitation, try to adjust the propeller pitch and/or the number of revolutions.

Reverberation

Reverberation is generated when the echoes from your sonar transmission are reflected not only by fish and objects in the water, but also from the bottom and the sea surface.

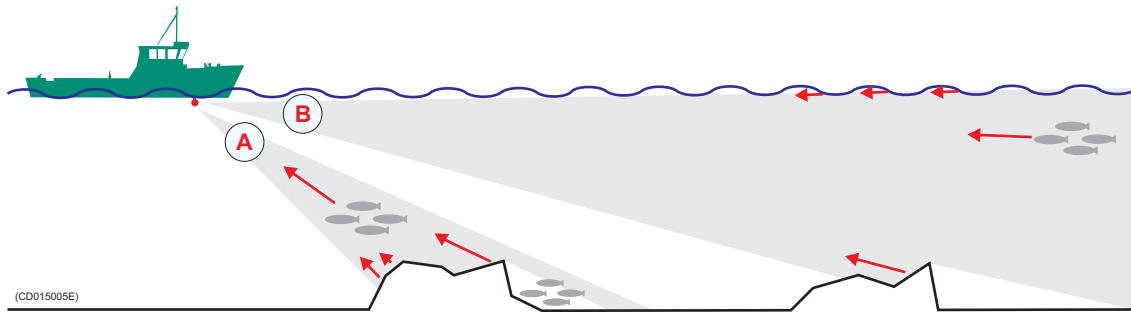

The echoes from the bottom will vary with how uneven the bottom is, what kind of bottom you have under your vessel, (rock, mud, sand etc.) as well as your current tilt setting. The echo from the sea surface will vary with the current sea state and your current tilt setting.

The illustration demonstrates how the bottom and the sea surface return echoes back to your sonar transducer. In situation (A) you will see several weak echoes from the waves and from the rock on the bottom, you will still be able to identify the school of fish. In situation (B) you will be able to identify the upper school of fish, but the lower school will be hidden in the shadow of the rock.

Be aware of that other vessels close to you will also generate reverberation due to the water disturbance caused by the wake, the propellers and the cooling water spill.

Blocking

The movement of your vessel through the water will often — especially in higher sea states — cause air bubbles to be generated, and these bubbles will move along the hull. This is called blocking. In order to prevent this noise from disturbing your sonar operations, it is important to lower the sonar transducer as far down below the hull as possible.

Check the noise yourself!

If you are bothered with acoustic or electric noise, you can easily run a few simple tests to identify the cause of the problem.

Check acoustic noise

- 1 Click the **Setup** tab to open the menu.
- 2 Click the **Test** button to open the **System test** menu.
- 3 Click the **Test config** button, and select **Noise and VR** in the parameter dialogue.
- 4 Click the **Close** button in the parameter dialogue to close it.
- 5 Observe the **Echo level** button on the **System test** menu, and read the noise level.

The level you read in the button is the current noise in the direction of the cursor. The noise is provided in dB, and the number should be as negative as possible. For example, a reading of -50 dB means that you have less noise than if you read -40 dB.

In order to reduce the noise, try to adjust the propeller pitch and the number of revolutions.

Check electrical noise

- 1 Switch off all electric equipment that can cause electrical noise.
- 2 Switch the equipment on again one at the time, and check the sonar every time.

With luck, you will spot which of your electrical systems that create the noise. To deal with the problem, consult your dealer and/or a certified ships electrician.

Layers and deflections

Your sonar operations may also be disturbed by environmental situations that you are unable to control. Two typical conditions are temperature and salinity layers, and deflections caused by increasing or decreasing water temperature.

Temperature and salinity layers

You may experience that temperature and/or salinity layers exist in the water column. Since the speed of sound in water depends on its temperature and salinity, such layers will cause the sound beam to be reflected.

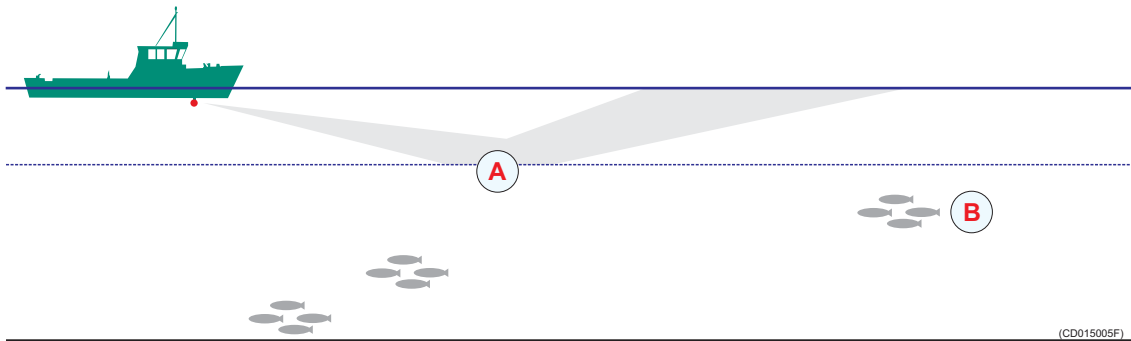

If you transmit a sonar beam down towards a temperature or salinity layer (A), it will be reflected as indicated in the illustration. The school of fish (B) you thought you would see will not be visible at all.

Deflections

On warm days — especially during summer — the sea surface will be heated by the sun, and the water temperature will gradually decrease with increasing depth.

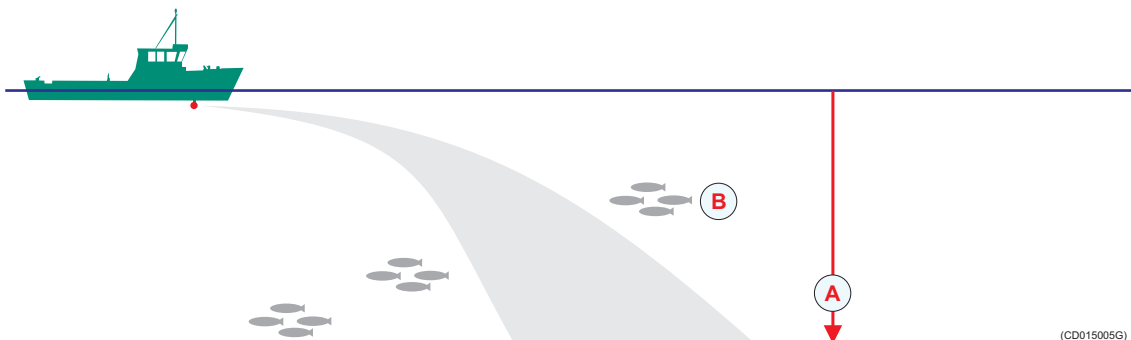

When the temperature decreases (A) closer to the bottom, the sonar beam is deflected down as indicated by the illustration. The school of fish (B) you thought you would see is not visible at all.

On cold days, you may experience the opposite: the cold water will be close to the surface, and the water temperature increases with increasing depth.

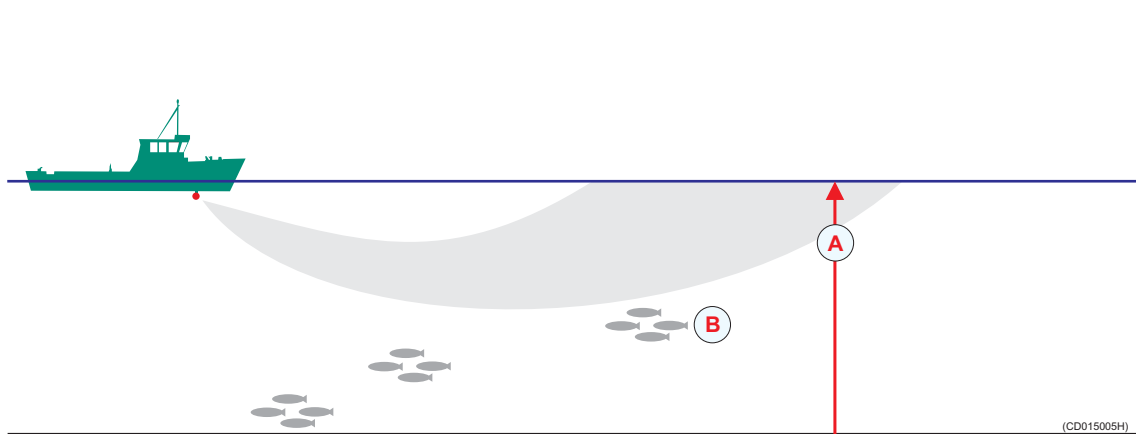

When the temperature decreases (A) closer to the surface, the sonar beam is deflected up as indicated by the illustration. The school of fish (B) you thought you would see is once again not visible at all, and you will also see a ring of surface echoes.

A

AGC control, 22
 AGC, theory, 33
 Automatic tilt, 29
 Automatic train, 29

B

Blocking, theory, 37

C

Cavitation, theory, 36
 CD, burn images, 28

D

Deflections, theory, 38
 Delete sonar images, 27
 Display Gain control, 23
 Display, menu, 18
 Docking, 6

F

Full menu, 21

G

Gain control, 22
 Gain settings, theory, 33

H

Horizontal search program, 29
 Horizontal, menu, 16

K

Keep sonar images, 26

L

Lines, target track, 31

M

Menu hide, 16, 21
 Menu retrieve, 16, 21
 Menu simplify, 21
 Menu, Display, 18
 Menu, Horizontal, 16
 Menu, Setup, 19
 Menu, Vertical, 17
 Mode buttons setup, 24

Mode select, 24
 Modes, sort, 24

N

Noise, test, 37
 Noise, theory, 35
 Normal menu, 21

O

Omni transmission, theory, 34
 Operational mode, select, 24

P

Position track, 30
 Power off, 9
 Power on, 8
 PP Filter, theory, 33
 Print sonar images, 27
 Pulse form, theory, 33
 Pulse length, theory, 33

R

RCG control, 22
 RCG, theory, 34
 Recall sonar images, 25
 Rename sonar images, 27
 Reverberation, theory, 35–36

S

Safety information, 6
 Salinity layers, theory, 38
 Search program,
 horizontal, 29
 Search program, vertical, 29
 Sector transmission,
 theory, 34
 Select operational mode, 24
 Setup, menu, 19
 Short menu, 21
 Software releases, 7
 Sonar images, burn on CD, 28
 Sonar images, delete, 27
 Sonar images, keep, 26
 Sonar images, print, 27
 Sonar images, recall, 25
 Sonar images, rename, 27
 Sonar images, store, 25
 Sort modes, 24
 Store sonar images, 25
 Switch off power, 9

Switch power on, 8

T

Target track, 30
 Target track lines, 31
 Temperature layers, theory, 38
 Theory, AGC, 33
 Theory, blocking, 37
 Theory, cavitation, 36
 Theory, deflections, 38
 Theory, gain settings, 33
 Theory, noise, 35
 Theory, omni transmission, 34
 Theory, PP Filter, 33
 Theory, pulse form, 33
 Theory, pulse length, 33
 Theory, RCG, 34
 Theory, reverberation, 35–36
 Theory, salinity layers, 38
 Theory, sector
 transmission, 34
 Theory, temperature layers, 38
 Theory, tilt, 34
 Theory, TVG, 32
 Tilt, theory, 34
 Track position, 30
 Track target, 30
 Tracking line, 31
 TVG control, 23
 TVG, theory, 32

V

Vertical search program, 29
 Vertical, menu, 17

ISBN-10: 82-8066-069-0
ISBN-13: 978-82-8066-069-5
©2006 Simrad

Simrad AS

Strandpromenaden 50
P.O.Box 111
N-3191 Horten,
Norway

Telephone: +47 33 03 40 00
Telefax: +47 33 04 29 87
www.simrad.com
simrad.sales@simrad.com

SIMRAD
A KONGSBERG Company